

TS SUPERIMPOSED
STEEL COVER

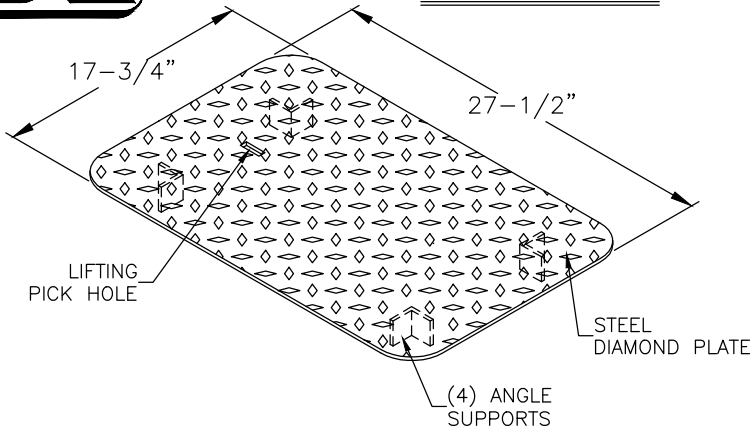

TF FLUSH
STEEL COVER

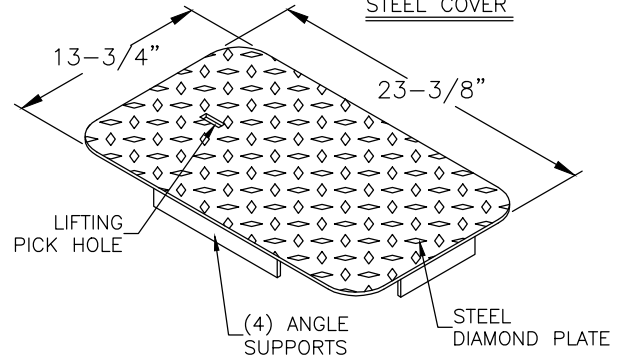

THS SUPERIMPOSED
STEEL COVER WITH
HINGED READING LID

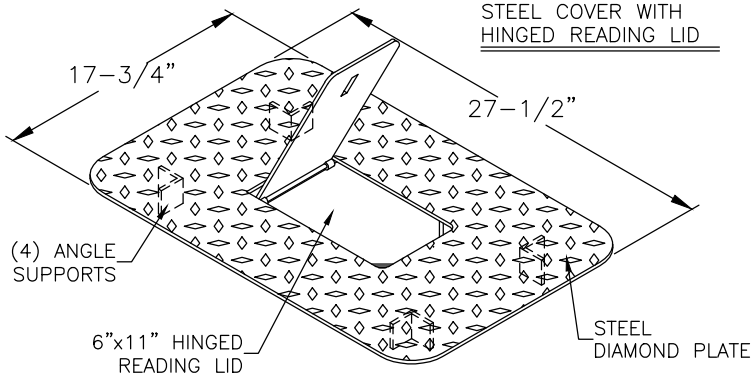

THF FLUSH
STEEL COVER WITH
HINGED READING LID

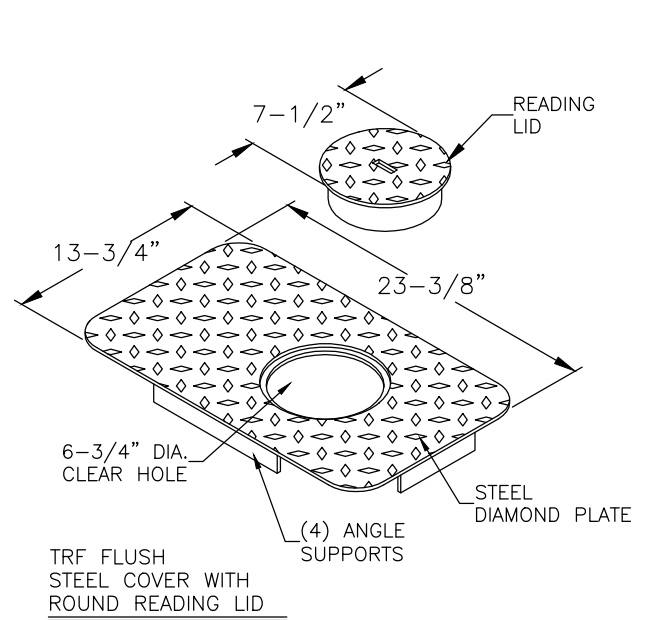
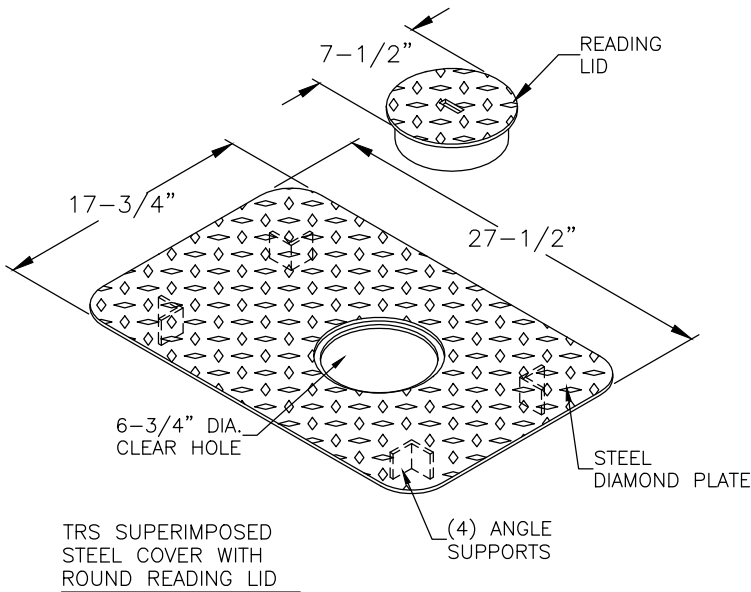
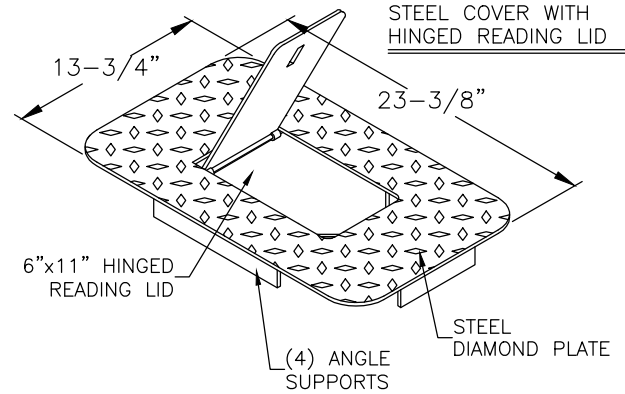

**W5-1/4 SERIES STEEL
DIAMOND PLATE COVERS**

J&R CONCRETE PRODUCTS

440 W. MARKHAM ST.
PERRIS, CA. 92571
PHONE:(951) 943-5855 FAX:(951) 940-9207