

Note:

Also Available w/ 4'X4' or 4'X5'
Opening (See Drawing 4040VCN
& 4050VCN)

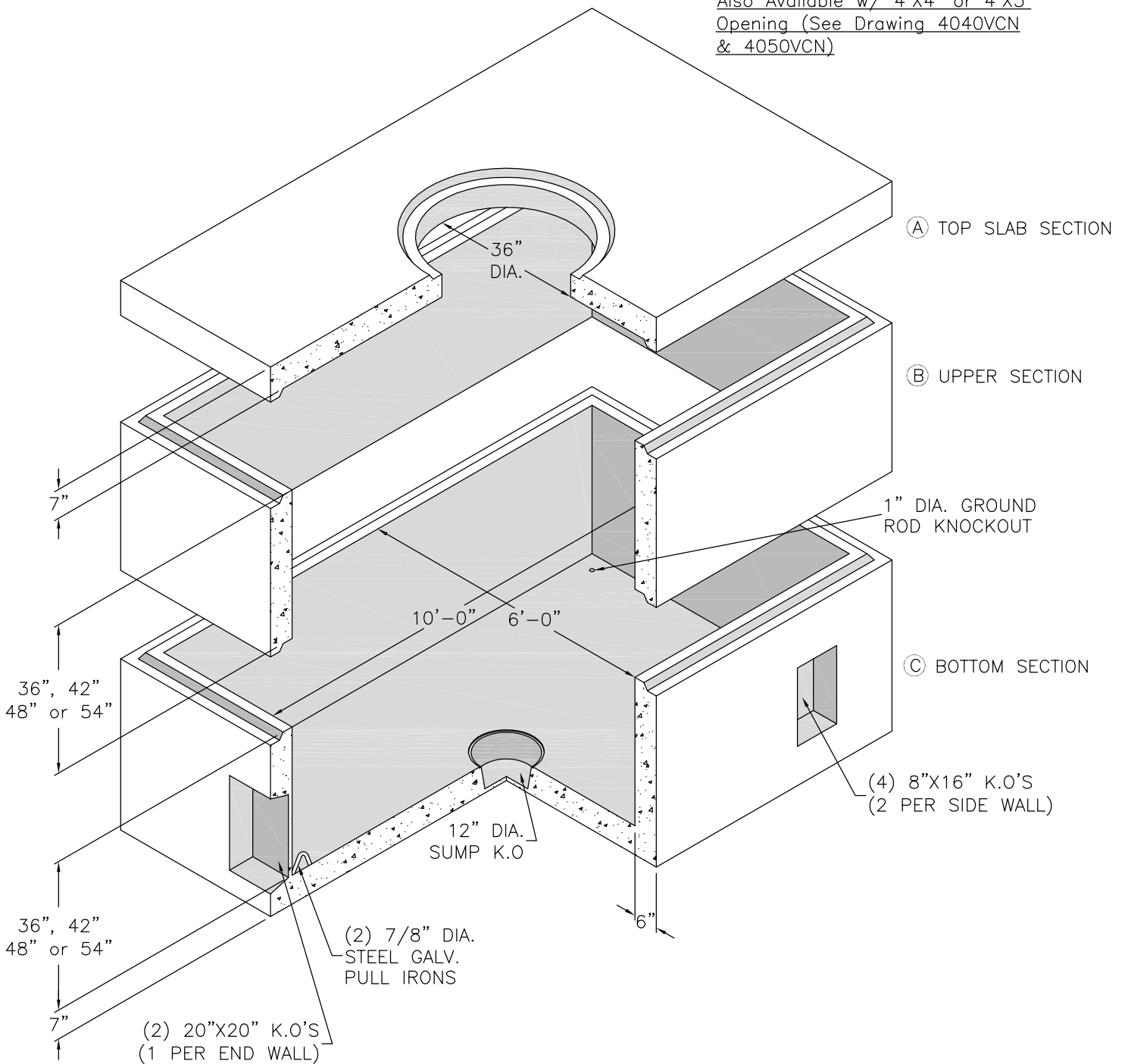

NOTE: Outside Dimensions of M.H.
7'-0"O.D x 11'-0"O.D

**6'-0" X 10'-0" CLOSED BOTTOM
ELECTRICAL MANHOLE VAULT
(SPECIAL DESIGN AVAILABLE)**

Notes:

1. Min. excavation size: 8'-0"x12'-0"x depth req'd.
2. Structures shall be placed on a minimum of 6" of crushed rock or sand.
3. Structures are designed for AASHTO H-20 Wheel Loading.